

Corredera en línea minimalista PSL

Secciones Técnicas

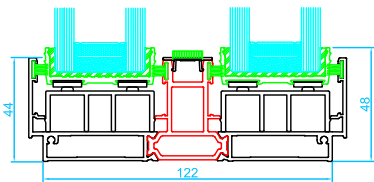

Marco de corredera
Hoja de corredera **RT54400**

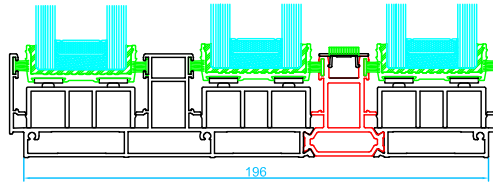

RT54403

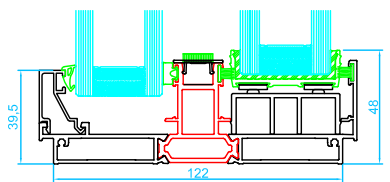

Marco de corredera con 1 hoja fija **RT54401**

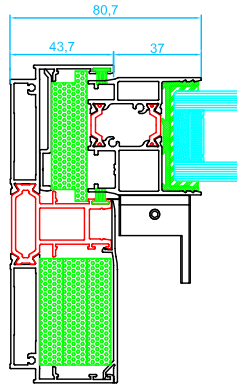

Marco de corredera sección lateral
Hoja de corredera

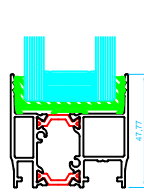

Hoja estándar **RT54410**

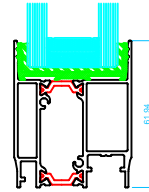

Hoja reforzada **RT54412**

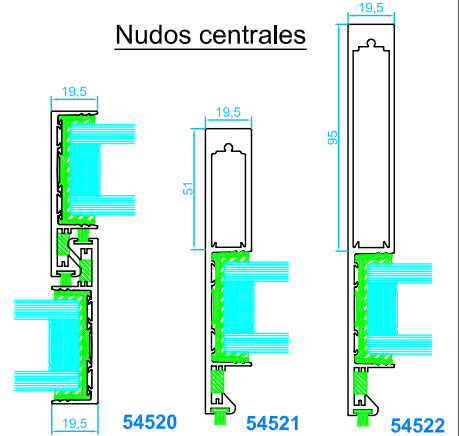

Cruce estándar

Cruce con refuerzo de Inercia

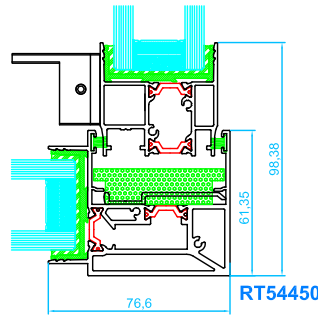

Encuentro en esquina 90° sin parteluces

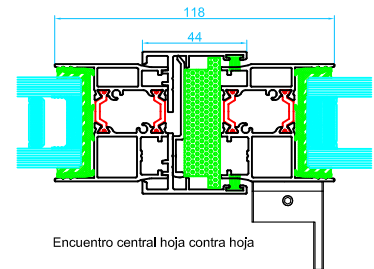

Encuentro central hoja contra hoja

Perfiles de unión

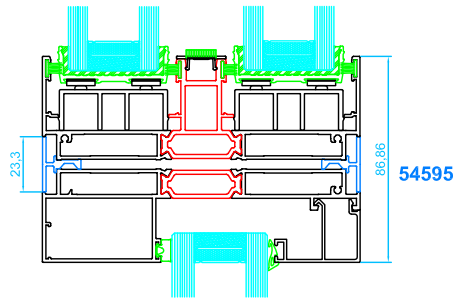

Unión marco corredera con fijo **54595**

Perfiles de canalización

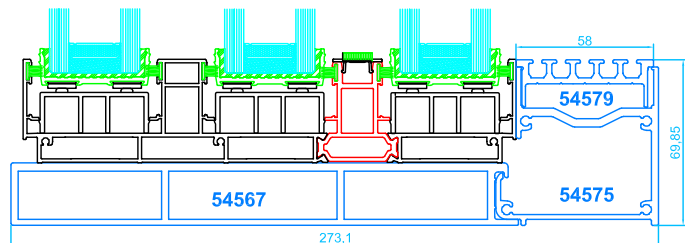
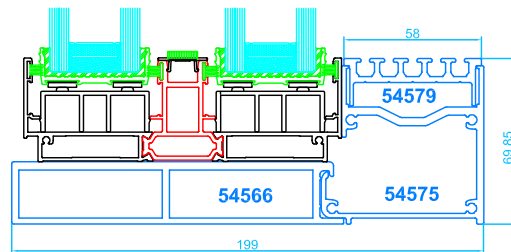

Tapajuntas

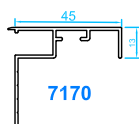

7170

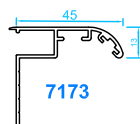

7173

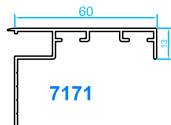

7171

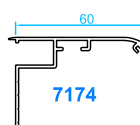

7174

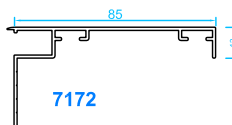

7172

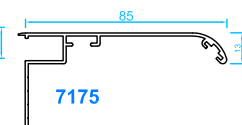

7175